

How to Draw a Pedigree

Please follow the instructions below when creating a pedigree. Additional resources can be found here: <http://www.nsgc.org/About/FamilyHistoryTool/tabid/226/Default.aspx>

Bennett, R.L., French, K.S., Resta, R.G. & Doyle, D.L. Standardized human pedigree nomenclature: update and assessment of the recommendations of the National Society of Genetic Counselors. *J Genet Couns* **17**, 424-33 (2008).

The following information must be included on the pedigree:

- First name or initials of relatives (To maintain confidentiality do NOT use full names; alternatively, use generation-individual numbers (I-1, I-2, II-1). Please limit identifying information to be compliant with HIPAA guidelines.)
- Affected status (i.e. who in the family has disease) for each individual in the family
- Age of all family members, or age at death (To be compliant with HIPAA guidelines, please do not submit a full birth date at this time.)
- Whether individuals are living or deceased. Cause of death, if known, should be indicated below the symbol.
- Residence for all family members (City, State)
- Willingness to participate in the study (indicate with an asterisk)
- Key to shading of symbols
- Adoption status
- Consanguinity (i.e. parents are related)
- Race and ethnicity
- Date pedigree obtained

General guidelines:

- It is helpful to start in the middle of the page when drawing a pedigree.
- Male partners are to the left of female partners.
- Siblings are drawn from oldest to youngest with the oldest listed on the left and the youngest on the right.
- If there are multiple disorders or diseases, use quadrants or different shading (solid, cross-hatching) to indicate each disease (see examples)

Instructions on How to Draw a Pedigree

Begin by drawing a solid square (male) or circle (female) for the first person with disease who presented to medical attention. This individual is called the **proband**. Place an arrow on the lower left corner of this individual to indicate he/she is the proband.



Write the person's first name, or initials below the symbol.



Write the person's current age below the symbol.

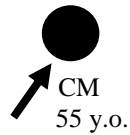

Indicate the disease or disorder the individual has along with the age of onset below the symbol.

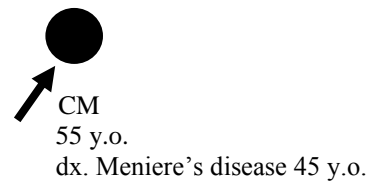

Next, draw the person's parents. To indicate partners/marriage draw a horizontal line connecting the two symbols (see below). If the individuals are **consanguineous** (i.e. related) indicate consanguinity with a double horizontal line. If the degree of consanguinity is not clear on the pedigree, please write above the relationship line, i.e. "2nd cousins."

Parents not related

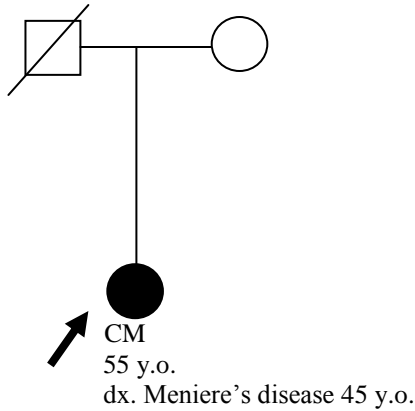

Parents consanguineous

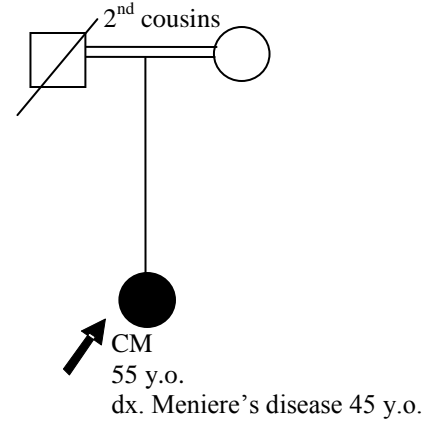

Add the parents current age, or age at death (d. age or year) with cause of death. Also, indicate any diagnoses (dx. Disease X) the individuals may have along with the age at diagnosis (dx. Disease X 50y.o.).

Parents not related

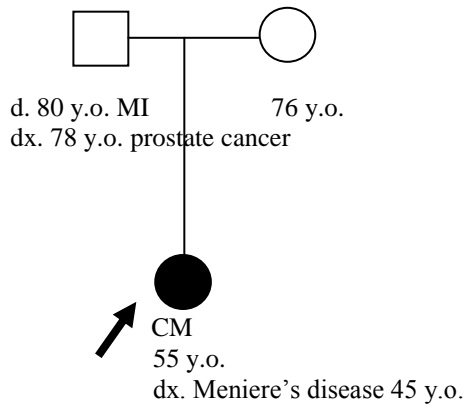

Parents consanguineous

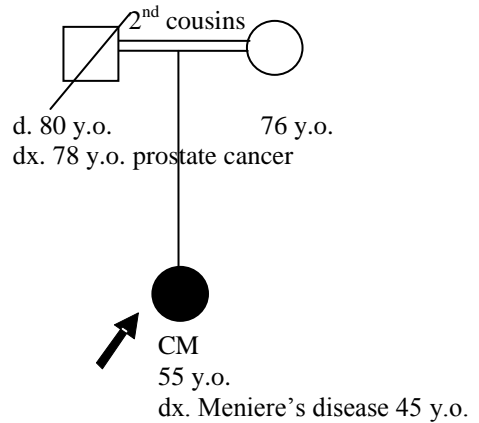

Draw any siblings in birth order from left (oldest) to right (youngest). Siblings are connected by a horizontal line above the symbols, with vertical lines connecting the symbols to the horizontal line. Leave space to add any partners and children.

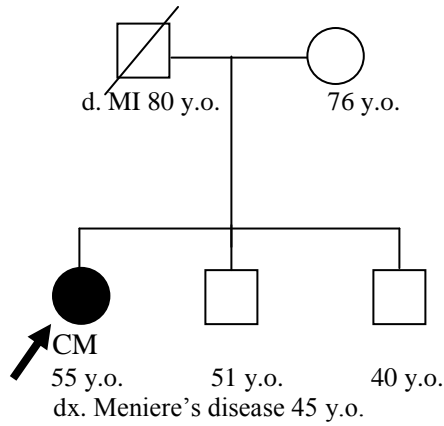

Add aunts, uncles, grandparents in the same manner. All affected individuals should be included in the pedigree and as many unaffected individuals as possible (parents, grandparents, and siblings of any affected individual).

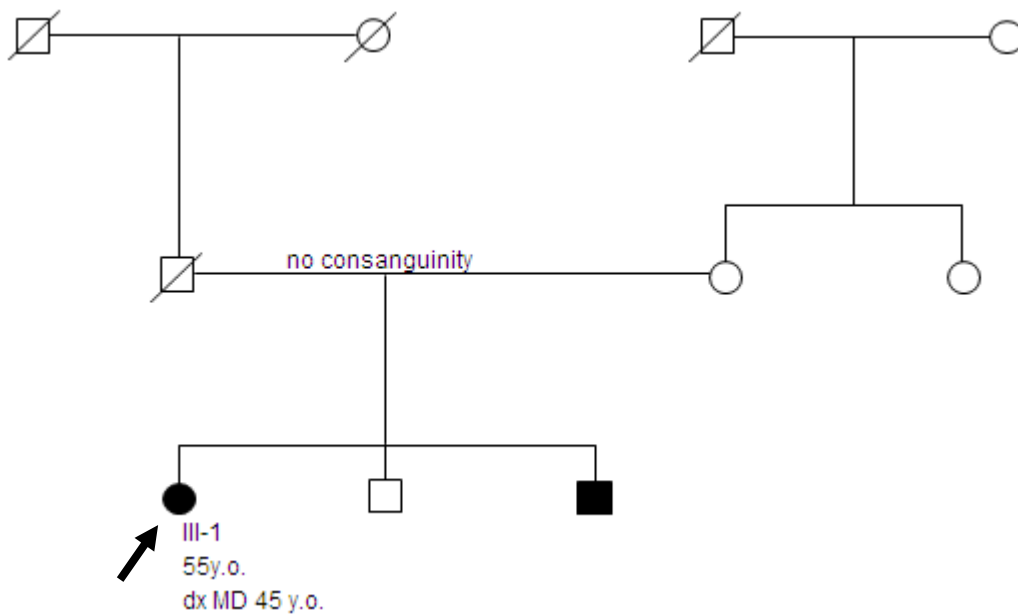

For each individual add the following below their symbol;

- Initials or generation number
- Current age (if known)
- Any diagnoses the individual has received along with the age of onset of the disorder.
- An asterisk (*) next to individuals willing to participate in the study.

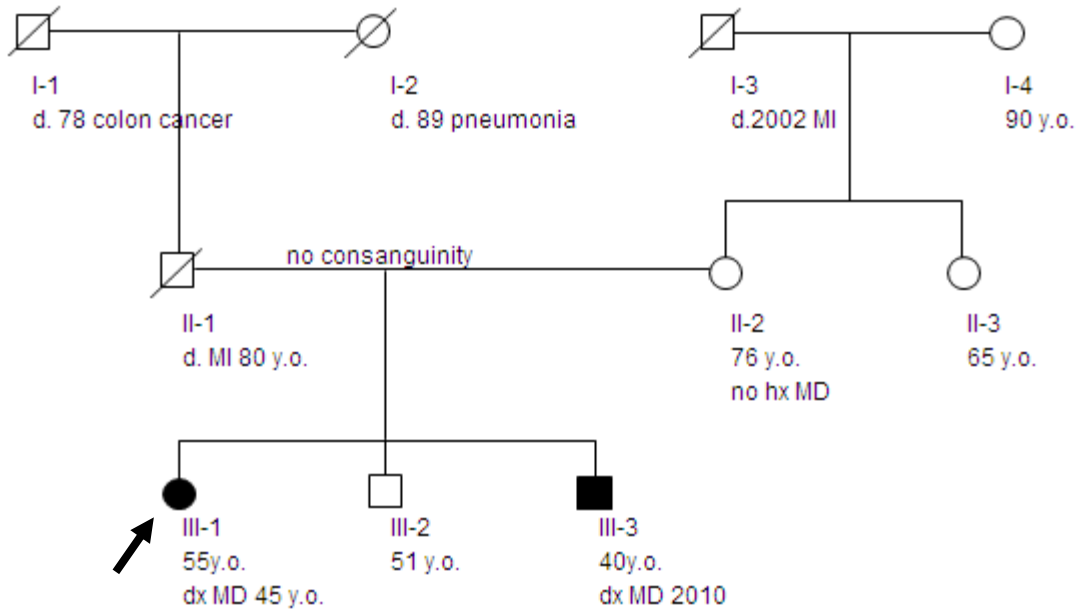

**The current place of residence (City, State) for each individual willing to participate in the study can be recorded on the pedigree, or must be provided to the IIHG as a separate list.

At the top of the pedigree write the ethnicity of each grandparent. Record the date the pedigree was obtained.

Obtained 1/23/2012

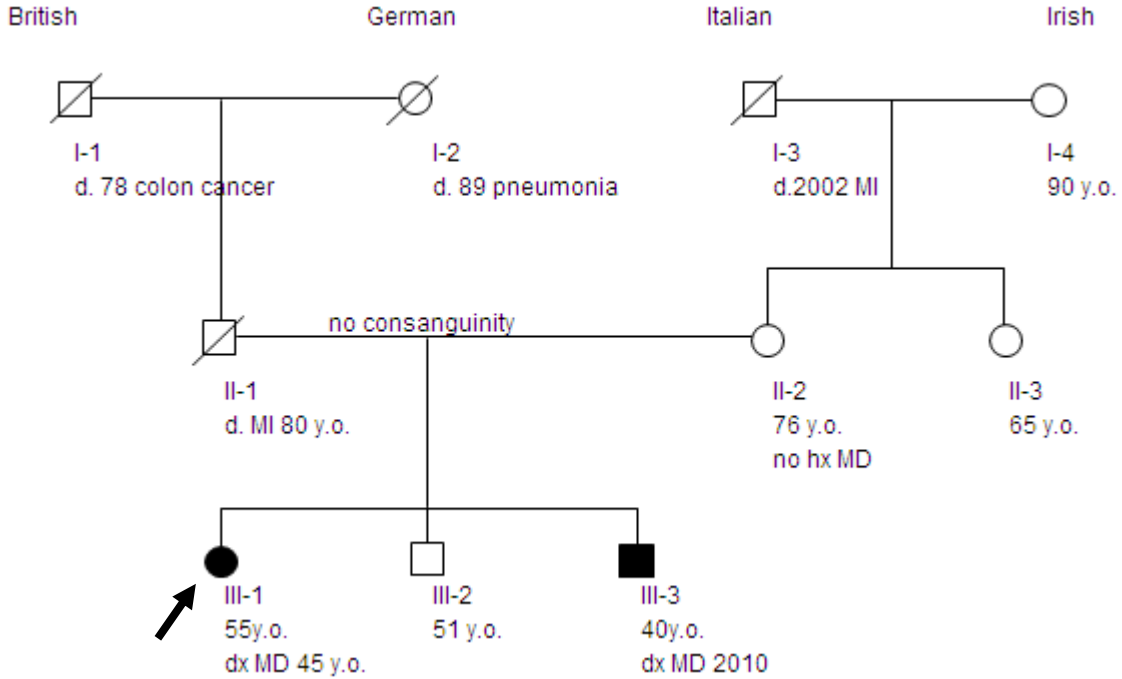

Finally, draw a key in the lower left corner indicating what the shading represents.

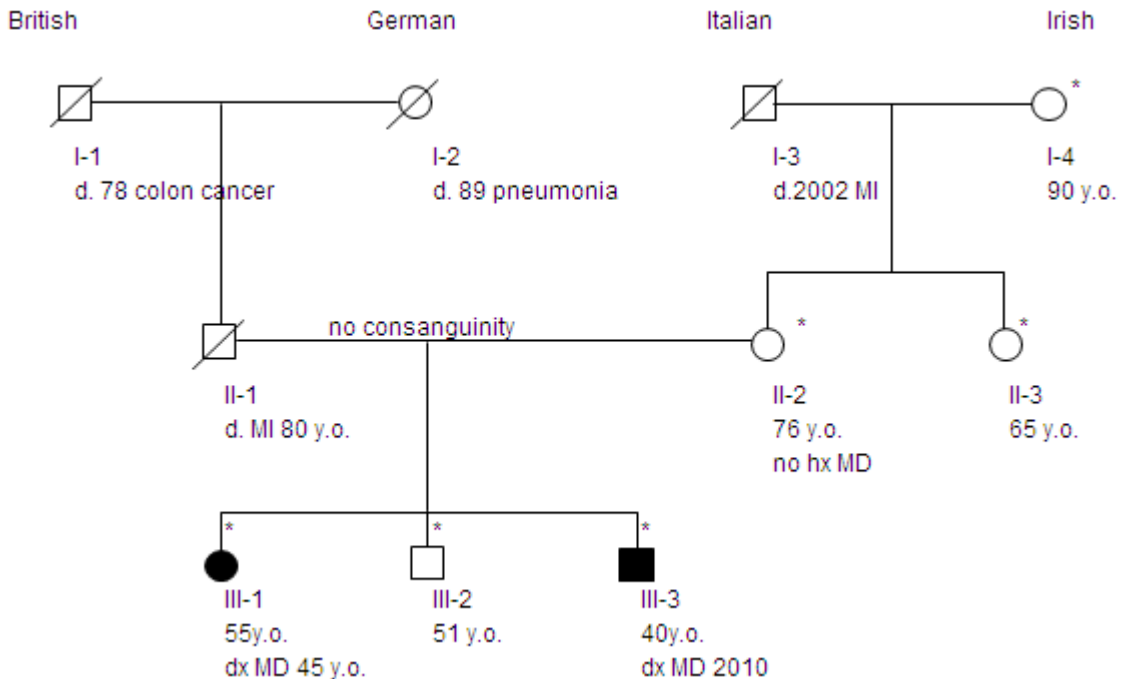

Key

● Menière's disease (MD)

Example Pedigrees

Autosomal Dominant Example: Marfan Syndrome

French Canadian / Norwegian

English / German

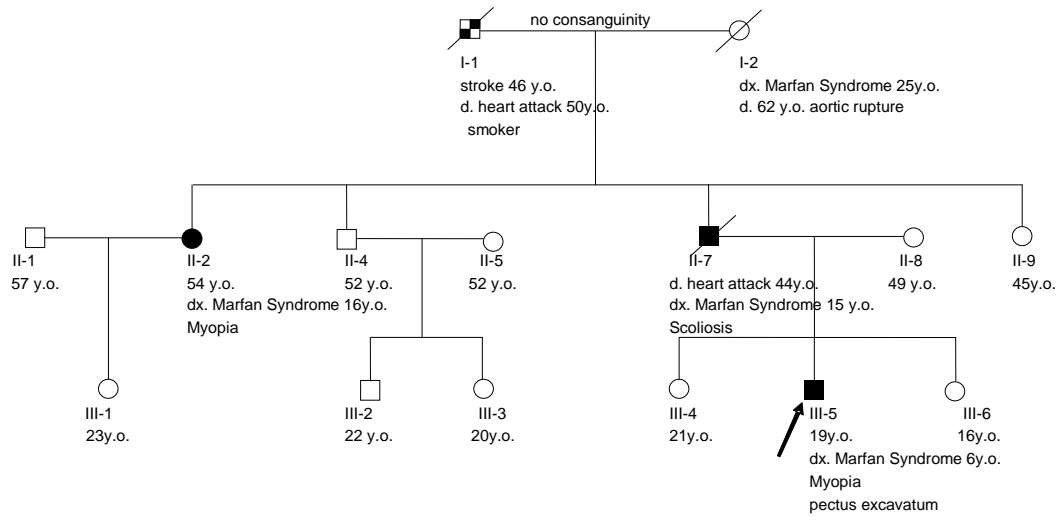

Key

- Marfan syndrome
- heart attack
- stroke

Autosomal Recessive Example: Cystic fibrosis

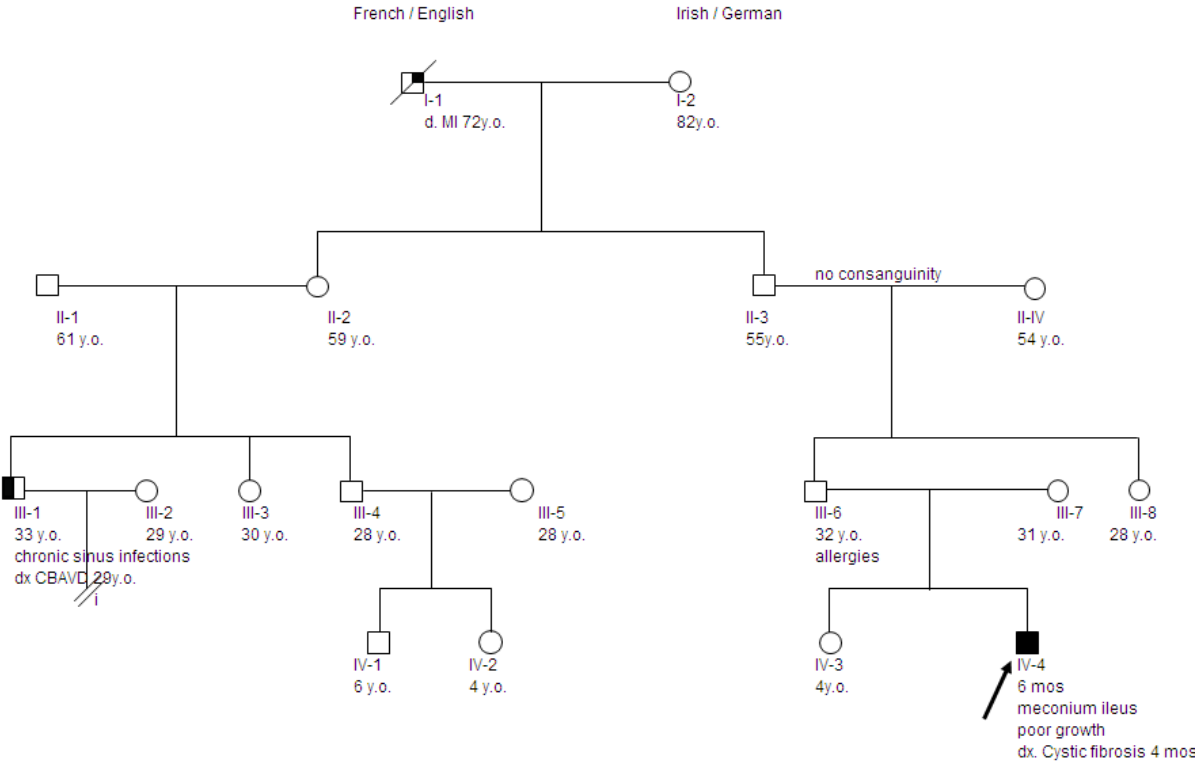

- Key
- Cystic fibrosis
 - ☐ heart attack
 - ☐ chronic sinus infections
 - ☐ congenital bilateral absence of the vas deferens (CBAVD)

Basic Pedigree Symbols

Living Unaffected female: Clear circle



Living Unaffected male: Clear square



Unknown gender: Clear diamond



Pregnancy symbols:

- Use a diamond if the gender is not yet known, a circle or a square if the gender is known.
- A triangle is used for any pregnancy not carried to term.
- Include gestational age, or estimated date of delivery (EDD) for all pregnancies.
- Pregnancy (P), Stillbirth (SB), Spontaneous abortion (SAB), Termination of pregnancy (TOP), Ectopic pregnancy (ECT).

Gender unknown



EDD 9/5/2012

Female fetus



EDD 9/5/2012

Male fetus



EDD 9/5/2012

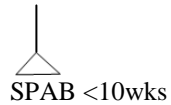

SPAB <10wks



TOP 12wks



ECT

Living Affected female: Black circle



Living Affected male: Black square



Adoption, place brackets around the adopted individual. A dashed offspring line indicates the individual was adopted into the family, and a solid line indicates the individual was adopted out of the family.

Adopted into family male

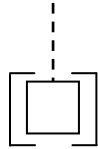

Adopted out of family male

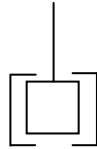

Deceased: symbol with a diagonal line

Deceased male

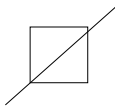

Deceased female

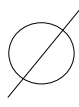

Individual with multiple diagnoses



Key



High cholesterol



Type II Diabetes

Basic Pedigree Lines

Marriage/Mating Line: horizontal line connecting 2 symbols at the center of each symbol

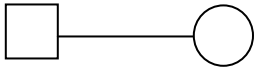

Separated, Divorce, Relationship no longer exists Line: horizontal line connecting 2 symbols with 2 diagonal hash marks.

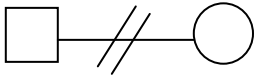

Offspring Line: Vertical line from the center of the mating line to the center of the offspring symbol or to the sibling line.

1 male child

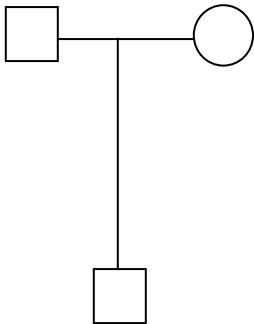

Children from a previous partner (stepchildren).

Mike and Jane have one son, and Jane has a daughter from a previous marriage.

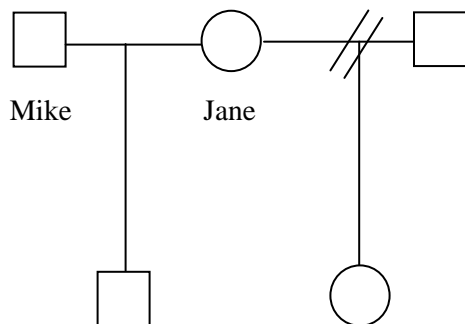

Sibling Line: Horizontal line above the offspring and connected by vertical lines. Example: brother and sister siblings.

Brother and sister siblings with two parents

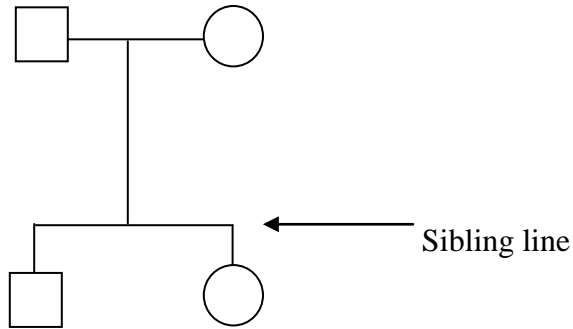

Twins: Indicated by two diagonal vertical lines originating from the same point.

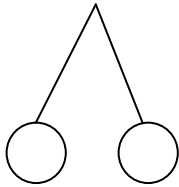

Monozygotic twins have a horizontal line connecting the diagonal lines.

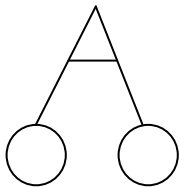

No children: A vertical line with 2 hash marks at the end. Indicate if an adult does not have children by choice (c), infertility (i).

